

Version 1.0

REPARATURSATZ, BREMSSATTEL *REPAIR KIT, BRAKE CALIPER*

Artikel article	OE Nr current comp no	OE 1	OE 2	OE 501
03.140.8830.001	09.801.06.31.0	4253 8002	81.50822.6023	K067417K50

Inhalt Content	St. Pcs
Caliper Pin - Ø 36/ 114 mm	1
Caliper Pin - Ø 32/ 80 mm	1
Caliper Pin Bolt - M16 x 1.5 / 85 mm	1
Caliper Pin Bolt - M16 x 1.5 / 80 mm	1
Caliper Pin Bush - Ø 36 x 40 / 82 mm	1
Caliper Pin Rubber Busg - Ø39 mm	1
Rubber Bush Stop Ring - Ø 35 mm	1
Caliper Pin Bolt Ring	1
Caliper Pin Boot	1
Caliper Pin Boot Ring	1
Caliper Pin Cap - Ø 40 / 14.5 mm	1
Caliper Pin Cap - Ø 54 / 28 mm	1
Caliper Pin Cap O-Ring	1
Grase (White) - 5 g	1

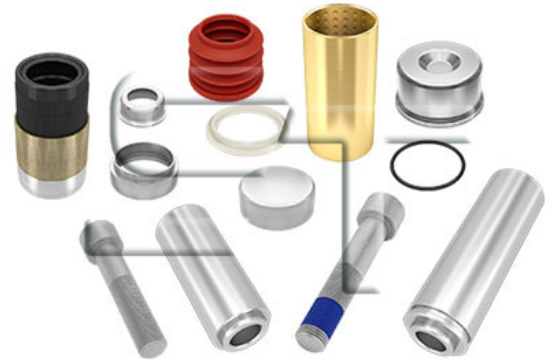

Artikel article	OE Nr current comp no	OE 1	OE 2	OE 501
03.140.8830.002	09.801.06.33.0	09.801.06.24.0	1639 100	K001915

Inhalt Content	St. Pcs
Caliper Pin - Ø 36/ 114 mm	1
Caliper Pin - Ø 32/ 80 mm	1
Caliper Pin Bolt - M16 x 1.5 / 85 mm	1
Caliper Pin Bolt - M16 x 1.5 / 80 mm	1
Caliper Pin Bush - Ø 36 x 40 / 82 mm	1
Caliper Pin Rubber Busg - Ø39 mm	1
Caliper Pin Boot	1
Caliper Pin Boot Ring	1
Caliper Pin Cap - Ø 40 / 14.5 mm	1
Grase (White) - 5 g	1

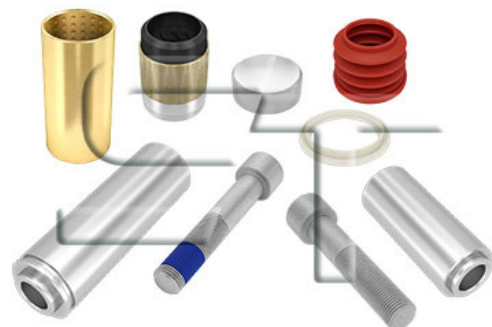

Artikel article	OE Nr current comp no	OE 1	OE 2	OE 501
03.140.8830.003	1 906 779	1 756 390		K011117

Inhalt Content	St. Pcs
Caliper Pin - Ø 36/ 114 mm	1
Caliper Pin - Ø 32/ 84 mm	1
Caliper Pin Bolt - M16 x 1.5 / 85 mm	1
Caliper Pin Bolt - M16 x 1.5 / 80 mm	1
Caliper Pin Bush - Ø 36 x 40 / 82 mm	1
Caliper Pin Rubber Busg - Ø39 mm	1
Caliper Pin Boot	1
Caliper Pin Boot Ring	1
Caliper Pin Boot	1
Caliper Pin Boot Ring	1
Caliper Pin Cap - Ø 54 / 28 mm	1
Caliper Pin Cap O-Ring	1
Caliper Pin Cap - Ø 40 / 36.5 mm	1
Caliper Pin Cap - Ø 40 / 14.5 mm	1
Grase (Green) - 5 g	1
Grase (White) - 5 g	1

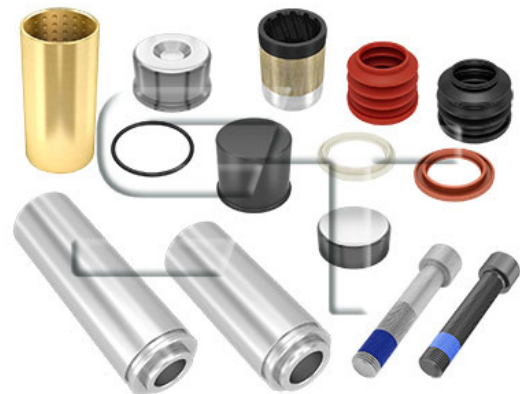

Artikel article	OE Nr current comp no	OE 1	OE 2	OE 501
03.140.8830.004	85 109 890	5001 866 989		MCK1298

Inhalt Content	St. Pcs
Caliper Pin - Ø 35 / 117 mm	1
Caliper Pin - Ø 31 / 78 mm	1
Caliper Pin Bolt - M18 x 1.5 / 120 mm	1
Caliper Pin Bolt - M18 x 1.5 / 80 mm	1
Caliper Pin Oval Bush - Ø 31-33 x 42 / 30 mm	1
Caliper Pin Bush - Ø 35x39 / 30 mm	2
Caliper Pin Boot Ring - Ø 37 x 39 / 10 mm	2
Caliper Pin Cap - Ø 44 / 17 mm	2
Caliper Bridge Bolt - M14 x 1.5 / 40 mm	4
Caliper Bridge Bolt - M16 x 1.5 / 40 mm	4
Caliper Pin Boot Ring - Ø 37 x 39 / 10 mm	2
Grease (White) - 5 g	1



Artikel article	OE Nr current comp no	OE 1	OE 2	OE 501
03.140.8830.005	1436 853	4253 6957		12 999 699VT

Inhalt Content	St. Pcs
Caliper Pin - Ø 30 / 91 mm	1
Caliper Pin - Ø 30 / 77 mm	1
Caliper Pin Bolt - M16 x 1.5 / 90 mm	1
Caliper Pin Bolt - M16 x 1.5 / 70 mm	1
Caliper Pin Bush - Ø 30 x 34 / 25 mm	3
Caliper Pin Cap - Ø 34 / 17 mm	2
Caliper Tappet Boot	1
Caliper Pin Boot	2
Caliper Head Cap	1
Grease (White) - 5 g	1

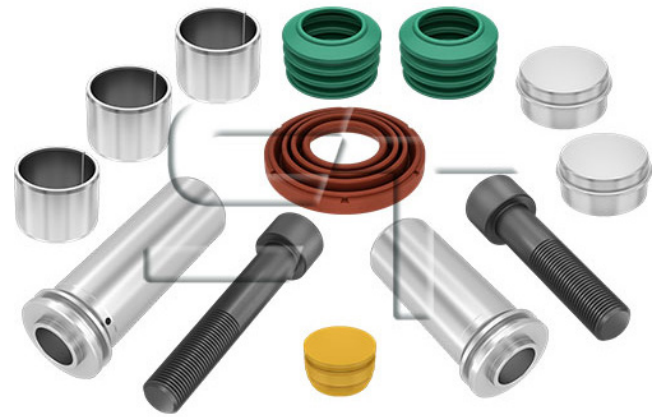

Artikel article	OE Nr current comp no	OE 1	OE 2	OE 501
03.140.8830.006	81.50802.6025	85 107 912	5001 860 791	MCK1243

Inhalt Content	St. Pcs
Caliper Pin - Ø 35 / 144 mm	1
Caliper Pin - Ø 31 / 84 mm	1
Caliper Pin Bolt - M18 x 1.5 / 150 mm	1
Caliper Pin Bolt - M18 x 1.5 / 90 mm	1
Caliper Pin Oval Bush - Ø 31-33 x 42 / 30 mm	1
Caliper Pin Bush - Ø 35 x 39 / 30 mm	2
Caliper Pin Boot Ring - Ø 37 x 42 / 14 mm	2
Caliper Pin Cap - Ø 45 / 28 mm	2
Brake Pad Retainer Bolt - M10 x 1.25 / 20 mm	1
Caliper Bridge Bolt - M16 x 1.5 / 40 mm	4
Caliper Pin Boot	2
Grease (White) - 5 g	1

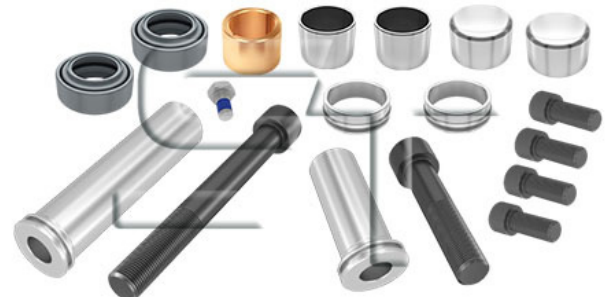

Artikel article	OE Nr current comp no	OE 1	OE 2	OE 501
03.140.8830.007	09.801.02.87.0	1448 915	1198 154	II33968/0062

Inhalt Content	St. Pcs
Caliper Pin - Ø 36 / 145 mm	1
Caliper Pin - Ø 34 / 80 mm	1
Caliper Pin Bolt - M16 x 1.5 / 150 mm	1
Caliper Pin Bolt - M16 x 1.5 / 85 mm	1
Caliper Pin Bush - Ø 36 x 40 / 82 mm	1
Caliper Pin Rubber Bush - Ø 34 x 40 / 50 mm	1
Caliper Pin Boot	1
Caliper Pin Boot Ring	1
Caliper Pin Bellow Cap	1
Caliper Pin Bellow Cap Clamp	1
Grease (White) - 5 g	1
Grease (Green) - 5 g	1

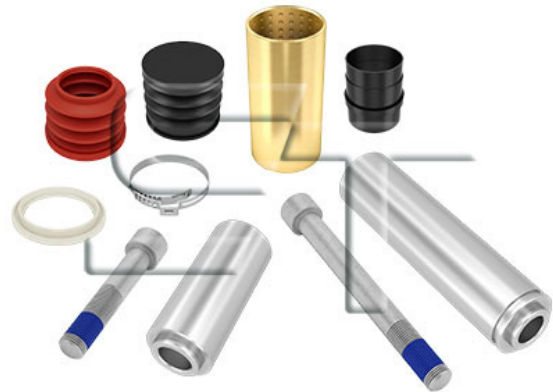

Artikel article	OE Nr current comp no	OE 1	OE 2	OE 501
03.140.8830.008	1448 910	3.434.3801.00	050 121 21 99	II36847/0064

Inhalt Content	St. Pcs
Caliper Pin - Ø 34 / 80 mm	1
Caliper Pin Bolt - M16 x 1.5 / 85 m	1
Caliper Pin Rubber Bush - Ø 34 x 40 / 50 mm	1
Grease (Green) - 8 g	1

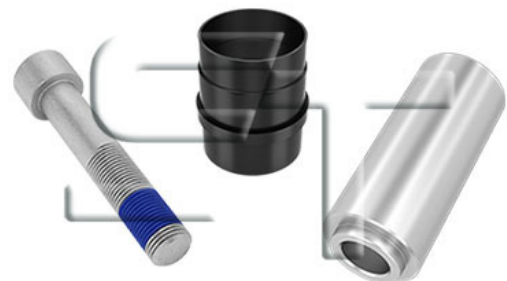

Artikel article	OE Nr current comp no	OE 1	OE 2	OE 501
03.140.8830.009	1505 890	3.434.3827.01	3.434.3827.00	12 999 738VT

Inhalt Content	St. Pcs
Caliper Pin - Ø 38 / 118 mm	1
Caliper Pin - Ø 37.7 / 76 mm	1
Caliper Pin Bolt - M16 x 1.5 / 120 mm	1
Caliper Pin Bolt - M16 x 1.5 / 80 mm	1
Caliper Pin Bush - Ø 38 x 42 / 30 mm	3
Caliper Pin Cap - Ø 42 / 28 mm	2
Caliper Pin Cap - Ø 42 / 17 mm	2
Caliper Tappet Boot	1
Caliper Pin Boot - White	2
Caliper Pin Boot	2
Caliper Pin Boot Ring	4
Caliper Head Cap	1
Grease (White) - 5 g	1



Artikel article	OE Nr current comp no	OE 1	OE 2	OE 501
03.140.8830.010	3.434.3815.00	000 420 50 82	000 420 56 82	K108002K50

Inhalt Content	St. Pcs
Caliper Pin - Ø 36 / 114 mm	1
Caliper Pin - Ø 36 / 64 mm	1
Caliper Pin Bolt - M16x 1.5 / 85 mm	1
Caliper Pin Bolt - M16x 1.5 / 70 mm	1
Caliper Pin Bush - Ø 36 x 40 / 82 mm	1
Caliper Pin Bush - Ø 36 x 40 / 20 mm	1
Caliper Pin Boot	2
Caliper Pin Boot Ring	2
Caliper Pin Cap - Ø 40 / 24.5 mm	1
Caliper Pin Cap - Ø 40 / 14.5 mm	1
Grease (White) - 5 g	2

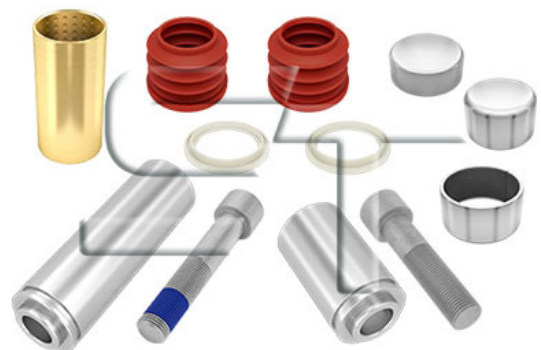

Artikel article	OE Nr current comp no	OE 1	OE 2	OE 501
03.140.8830.011	85 102 094			MCK1116

Inhalt Content	St. Pcs
Caliper Pin - Ø 35 / 102 mm	1
Caliper Pin - Ø 35 / 60 mm	1
Caliper Pin Bolt - M20 x 2 / 125 mm	1
Caliper Pin Bolt - M20 x 2 / 80 mm	1
Caliper Pin Fiber Bush - Ø 35 x 39 / 77 mm	1
Caliper Pin Oval Bush - Ø 35-36 x 39 / 30 mm	1
Caliper Pin Boot Ring - Ø 37 x 40 / 11 mm	2
Caliper Pin Cap - Ø 40 / 18.5 mm	2
Caliper Pin Boot	2
Grease (White) - 5 g	2

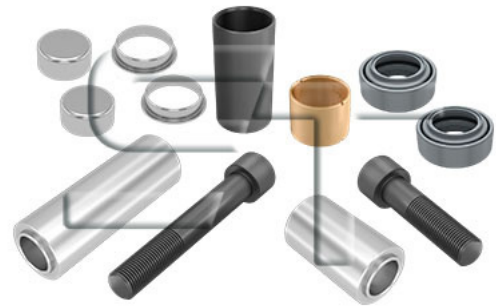

Artikel article	OE Nr current comp no	OE 1	OE 2	OE 501
03.140.8830.012	000 420 10 82	000 420 21 82	1 390 426	II32809/0063

Inhalt Content	St. Pcs
Caliper Pin - Ø 36 / 135 mm	1
Caliper Pin - Ø 36 / 80 mm	1
Caliper Pin Bolt - M16 x 1.5 / 140 mm	1
Caliper Pin Bolt - M16 x 1.5 / 85 mm	1
Caliper Pin Bush - Ø 36 x 40 / 50 mm	1
Caliper Pin Rubber Bush - Ø 34 x 40 / 50 mm	1
Caliper Pin Boot	1
Caliper Pin Boot Ring	1
Caliper Pin Bellow Cap	1
Caliper Pin Bellow Cap Clamp	1
Grease (White) - 5 g	1
Grease (Green) - 8 g	1



Artikel article	OE Nr current comp no	OE 1	OE 2	OE 501
03.140.8830.013	81.50802.6021	81.50802.6020	81.50802.6017	MCK1102

Inhalt Content	St. Pcs
Caliper Pin - Ø 35 / 135 mm	1
Caliper Pin - Ø 35 / 73mm	1
Caliper Pin Bolt - M20 x 1.5 / 150 mm	1
Caliper Pin Bolt - M20 x 1.5 / 90 mm	1
Caliper Pin Oval Bush - Ø 35-37 x40 / 33mm	1
Caliper Pin Bush - Ø 35 x 39 / 30 mm	2
Caliper Pin Boot Ring - (With Step) - Ø 36-37 x 39 / 15 mm	1
Caliper Pin Boot Ring - (With Step) - Ø 37 x 40 / 15 mm	1
Caliper Pin Boot Ring - Ø 37 x 48 / 14 mm	2
Caliper Pin Cap - Ø 45 / 28 mm	2
Caliper Pin Boot	2
Grease (White) - 5 g	1

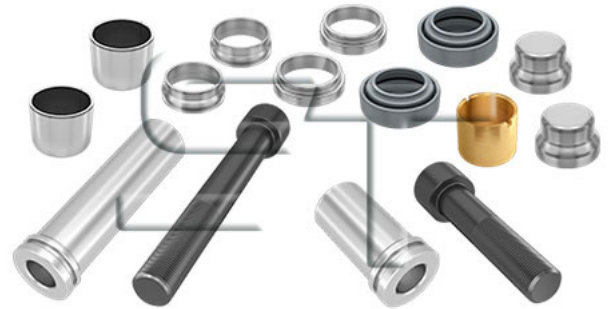

Artikel article	OE Nr current comp no	OE 1	OE 2	OE 501
03.140.8830.501	09.801.06.32.0	09.801.66.32.0	1689 313	K010603

Inhalt Content	St. Pcs
Caliper Thrust Part with Bellow - Ø 69 mm	2
Caliper Shaft Housing Boot - Ø 69 mm	2
Caliper Tappet Bush - Ø 16 x 18 / 10 mm	2
Grease (White) - 5 g	1

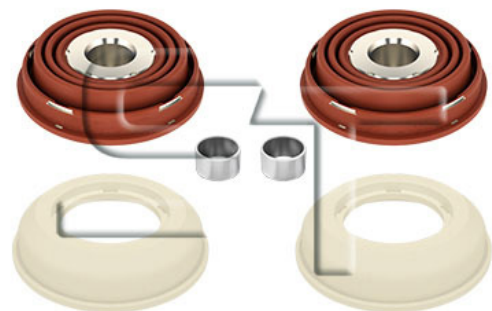

Artikel article	OE Nr current comp no	OE 1	OE 2	OE 501
03.140.8830.502	09.801.02.63.0	9316 2050	4255 3530	K010604

Inhalt Content	St. Pcs
Caliper Thrust Part with Bellow - Ø 74 mm	2
Caliper Shaft Housing Boot - Ø 74 mm	2
Caliper Tappet Bush - Ø 16 x18 / 10 mm	2
Grease (White) - 5 g	1

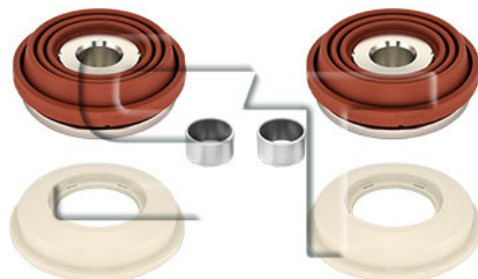

Artikel article	OE Nr current comp no	OE 1	OE 2	OE 501
03.140.8830.503	3.434.3829.00			640 175 920 2

Inhalt Content	St. Pcs
Caliper Tappet Boot	1
Caliper Head Seal	1
Caliper Head Cap	1
Seal Mounting Cap	1
Seal Mounting Bushing	1



Artikel article	OE Nr current comp no	OE 1	OE 2	OE 501
03.140.8830.504	81.50802.6024	85 107 913		MCK1139

Inhalt Content	St. Pcs
Caliper Tappet Boot	2

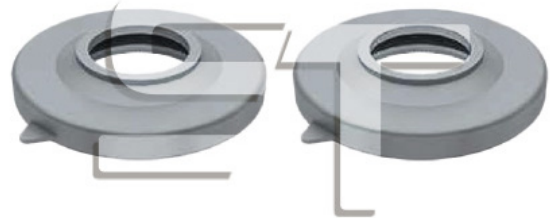

Artikel article	OE Nr current comp no	OE 1	OE 2	OE 501
03.140.8830.505	000 423 03 16			K046523K50

Inhalt Content	St. Pcs
Caliper Thrust part with Bellow - Ø 69 mm	2
Caliper Shaft Housing Boot - Ø 69 mm	2
Caliper Tappet Bush - Ø 15 x 17 / 8 mm	2
Grease	1

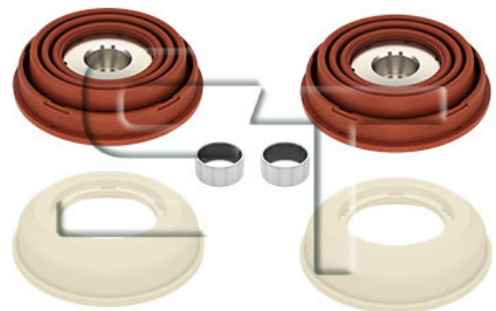

Artikel article	OE Nr current comp no	OE 1	OE 2	OE 501
03.140.8830.506	3092 264			MCK1238

Inhalt Content	St. Pcs
Caliper Tappet Boot	2
Caliper Tappet	2
Caliper Tappet Clips	2

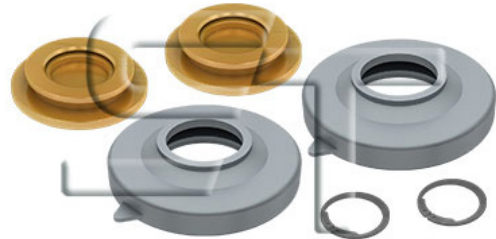

Artikel article	OE Nr current comp no	OE 1	OE 2	OE 501
03.140.8830.507	85 109 889			MCK1317

Inhalt Content	St. Pcs
Caliper Pin - Ø 35 / 117 mm	1
Caliper Pin - Ø 31 / 117 mm	1
Caliper Pin Bolt - M18 x 1.5 / 120 mm	2
Caliper Pin Oval Bush - Ø 31-33 x 42 / 30 mm	2
Caliper Pin Boot Ring - Ø 37 x 39 / 10 mm	2
Caliper Pin Bush - Ø 35 x 39 / 30 mm	2
Caliper Pin Cap - Ø 44 / 17 mm	2
Caliper Bridge Bolt - M16 1.5 / 40 mm	4
Caliper Pin Boot Ring - Ø 37 x 39 / 10 mm	2
Grease	1



Artikel article	OE Nr current comp no	OE 1	OE 2	OE 501
03.140.8830.508	85 109 891	5001 866 398		MCK1309

Inhalt Content	St. Pcs
Caliper Tappet Boot	2
Caliper Tappet	2
Caliper Tappet Ring	2

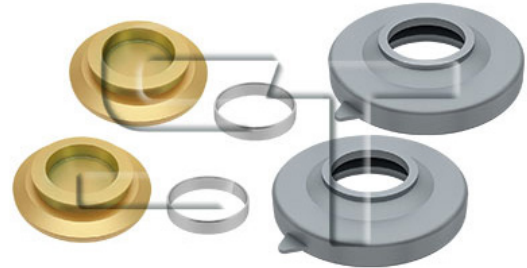

Artikel article	OE Nr current comp no	OE 1	OE 2	OE 501
03.140.8830.509	09.801.06.90.0			

Inhalt Content	St. Pcs
Caliper Pin - Ø 32 / 80 mm	1
Caliper Pin Bolt - M16 x 1.5 / 80 mm	1
Caliper Pin Rubber Bush - Ø 35 mm	1
Caliper Pin Bolt Ring	1



Artikel article	OE Nr current comp no	OE 1	OE 2	OE 3	OE 501
03.140.8830.510	09.801.07.05.0	000 420 4182	81.50822.6026	2121650	K001928

Inhalt Content	St. Pcs
Caliper Pin - Ø 30 / 99 mm	1
Caliper Pin - Ø 30 / 72 mm	1
Caliper Pin Bolt - M16 x 1.5 / 105 mm	1
Caliper Pin Bolt - M16 x 1.5 / 75 mm	1
Caliper Pin Boot	2
Caliper Pin Boot Ring	2
Caliper Pin Bush - Ø 30 x 34 / 65 mm	1
Caliper Pin Bush - Ø 30 x 34 / 20 mm	1
Caliper Pin Cap - Ø 34 / 14 mm	2
Grease	1



Artikel article	OE Nr current comp no	OE 1	OE 2	OE 501
03.140.8830.511				

Inhalt Content	St. Pcs
Caliper Adjusting Mechanism Shaft	1

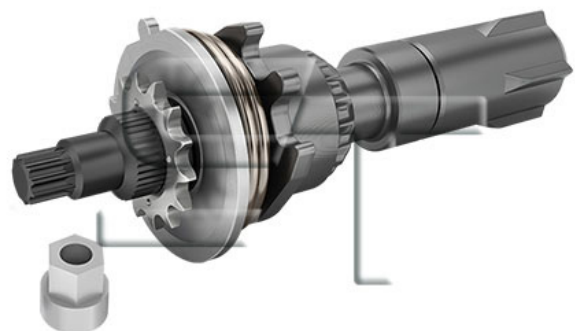

Artikel article	OE Nr current comp no	OE 1	OE 2	OE 501
03.140.8830.512	000 420 0782	000 420 2282		K000365

Inhalt Content	St. Pcs
Caliper Pin - Ø 36 / 114mm	1
Caliper Pin - Ø 32 / 80mm	1
Caliper Pin - Ø 34 / 80mm	1
Caliper Pin Bolt - M16 x 1.5 / 85 mm	2
Caliper Pin Bolt - M16 x 1.5 / 80 mm	1
Caliper Pin Bush - Ø36 x 40 / 82 mm	1
Caliper Pin Rubber Bush - Ø34 x 40 / 50 mm	1
Caliper Pin Rubber Bush - Ø39 mm	1
Caliper Pin Boot	1
Caliper Pin Boot Ring	1
Caliper Pin Cap - Ø 40 / 11 mm	1
Caliper Pin Cap - Ø 54 / 28 mm	1
Caliper Pin Cap O-Ring	1
Grease	1



Artikel article	OE Nr current comp no	OE 1	OE 2	OE 501
03.140.8830.513	3 434 3815 00	1527854 2198395 2121647 1748131 000 420 5082 1482003	1008450	K010766 L004168 K010766 K004100

Inhalt Content	St. Pcs
Caliper Pin - Ø 34 / 114 mm	1
Caliper Pin - Ø 34 / 64 mm	1
Caliper Pin Bolt - M16 x 1.5 / 85 mm	1
Caliper Pin Bolt - M16 x 1.5 / 70 mm	1
Caliper Pin Bush - Ø 36 x 40 / 82 mm	1
Caliper Pin Bush - Ø 36 x 40 / 20 mm	1
Caliper Pin Boot	2
Caliper Pin Boot Ring	2
Caliper Pin Cap - Ø 40 / 24.5 mm	1
Caliper Pin Cap - Ø 40 / 14.5 mm	1
Grease	2

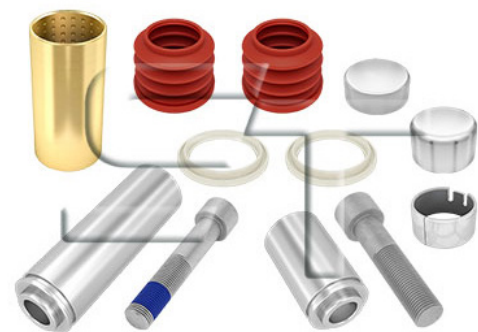

Artikel article	OE Nr current comp no	OE 1	OE 2	OE 501
03.140.8830.514				

Inhalt Content	St. Pcs
Caliper Adjusting Mechanism Shaft	1



Qualität Quality

Templin Produkte sind hinsichtlich ihrer Materialspezifikationen, Fertigungstoleranzen und Produkteigenschaften exakt definiert. Unser nach DIN EN ISO 9001 zertifiziertes Qualitätsmanagementsystem gewährleistet eine jederzeit transparente und zuverlässige Prozesskette innerhalb unserer Supply-Chain.

Templin products are precisely defined in terms of material specifications, manufacturing tolerances and product properties. Our DIN EN ISO 9001 certified quality management system guarantees a transparent and reliable process chain within our supply chain at all times.



Allgemeine Informationen General Information



Es gelten ausschließlich unsere Verkaufsbedingungen. Die angegebenen Preise sind freibleibend. Bitte beachten Sie, dass sich alle Preise zzgl. MwSt verstehen. Irrtümer, Lieferfähigkeit und Preisanpassungen bleiben vorbehalten. Jedwede Bestellung bedarf unserer schriftlichen Zusage für eine Bindungswirkung. Technische Änderungen bleiben - auch ohne entsprechende Information in jedem Einzelfall - vorbehalten.

Die angebotenen Teile sind Nachbauteile. Die dabei angegeben Original-Ersatzteilnummern dienen nur zu Vergleichszwecken; diese Informationen wurden nach bestem Wissen sorgfältig zusammengestellt, jedoch können Irrtümer nicht ausgeschlossen werden. Für die Richtigkeit der Angaben können wir keine Gewähr übernehmen. Die Verwendungsfähigkeit muss vor jedem Einbau geprüft werden.

Montageanleitungen liegen nicht in allen Fällen bei. Soweit Sie oder Ihre Kunden gleichwohl Montageanleitungen benötigen, fragen Sie uns vor der Bestellung. Sämtliche Produkte sollten ausschließlich genau ihrer vorgesehenen Verwendung und nur von fachlich geschultem Personal eingebaut werden. Jegliche Haftung für Schäden, die aufgrund der Missachtung dieses Installationshinweises entstehen, wird abgelehnt. Diese Haftungsbeschränkung gilt jedoch nicht für die Haftung von Templin Automotive GmbH bzw. ihrer Angestellten, Arbeitnehmer, Mitarbeiter, Vertreter und Erfüllungshilfen wegen vorsätzlichen Verhaltens oder grober Fahrlässigkeit, für garantierte Beschaffenheitsmerkmale, wegen Verletzung des Lebens, des Körpers oder der Gesundheit oder nach dem Produkthaftungsgesetz.

Dieser Katalog ist urheberrechtlich geschützt. Jegliche Vervielfältigung (auch Nachdrucke) und Verarbeitung bedarf des schriftlichen Einverständnisses der Herausgeberin.

Our terms of sale apply exclusively. The indicated prices are subject to change. Please note that all prices are exclusive of VAT. Errors, availability and price adjustments remain reserved. Any order requires our written confirmation for a binding effect. We reserve the right to make technical changes - even without appropriate information in each individual case.

The parts offered are imitation parts. The original spare part numbers quoted are for comparison purposes only; this information has been carefully compiled to the best of our knowledge, but errors cannot be excluded. We cannot guarantee the correctness of the information. The usability must be checked before each installation.

Installation instructions are not always included. If you or your customers need assembly instructions nevertheless, please ask us before ordering. All products should only be installed in accordance with their intended use and only by professionally trained personnel. Any liability for damages caused by disregarding this installation instruction is rejected. However, this limitation of liability does not apply to the liability of Templin Automotive GmbH or its employees, workers, co-workers, representatives and vicarious agents due to intentional conduct or gross negligence, for guaranteed characteristics, due to injury to life, body or health or according to the Product Liability Act.

This catalogue is protected by copyright. Any reproduction (including reprints) and processing requires the written consent of the publisher.

TEMPLIN

A U T O M O T I V E

Domänenweg 1 | 31863 Coppenbrügge | *Germany*
Fon: +49 5156 9610-0 | Fax: +49 5156 9611-96
info@templin-automotive.de | www.templin-automotive.de